

The shape of things to come.

R39

Amphenol's rectangular connector soars to meet higher expectations.

- Rectangular space savings
- Low profile
- High density 127 position inserts or mixed inserts with power, RF or fibre-optic available
- Blind mate
- Rugged
- Uses same contacts as standard 38999

Dynamically engineered for a changing world.



Everything you expect in a
38999 and more...

R39

- Rectangular 38999
- Rugged
- Blind Mate

Available with EMI filtering

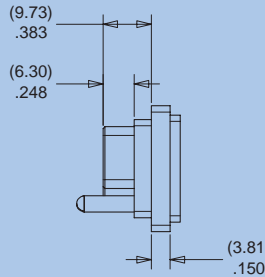
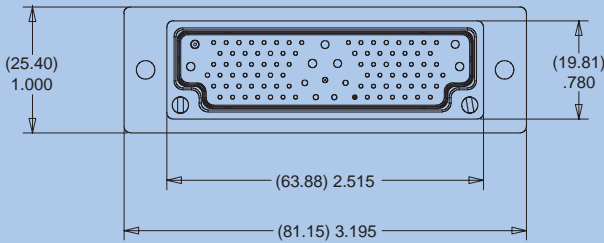

BLIND MATE GUIDE PINS

CRIMP CONTACTS PER
MIL-DTL-38999

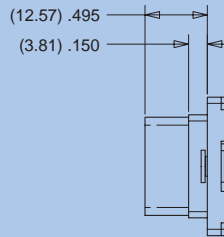
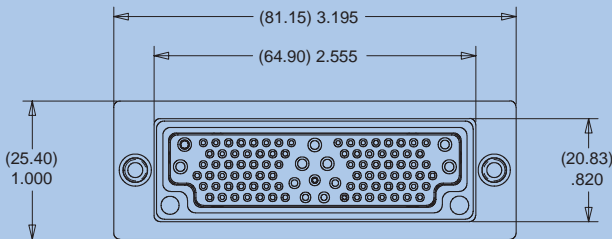
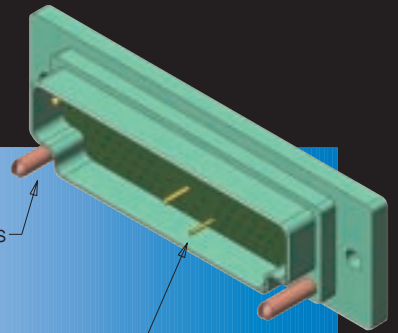

CONTACTS
AVAILABLE WITH
CRIMP, PCB OR
COMPLIANT

BUILT IN
PCB STANDOFF

AVAILABLE
FLOAT MOUNT
OR THRU HOLE

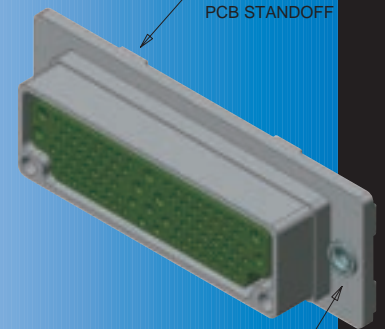

R39 Amphenol

Aerospace Products

ELECTRICAL CHARACTERISTICS

- DIELECTRIC WITHSTANDING VOLTAGE:
1500 VAC @ SEA LEVEL
500 VDC @ 70,000 FT.
 - INSULATION RESISTANCE: 5000 MEGOHMS @ 500 VDC
 - CONTACTS:
PER M39029/57 AND M39029/58 FOR SIGNAL AND POWER
PER M39029/102 AND 103 FOR COAX
FIBRE-OPTIC CONTACTS AVAILABLE
 - CONTACT TERMINATIONS: CRIMP, PCB, COMPLIANT
 - MATERIALS:
SHELL: ALUMINUM ALLOY
INSERT: THERMOPLASTIC PER MIL-P-46185
HARDWARE: CRES
CONTACT RETENTION: BeCu
- AVAILABLE SHELL FINISHES:
ELECTROLESS NICKEL,
OD CHROMATE OVER CADMIUM
ZINC NICKEL
TIN
GOLD

ENVIRONMENTAL CHARACTERISTICS:

- THERMAL SHOCK: MIL-STD-202, METHOD 107, COND. A
- PHYSICAL SHOCK: MIL-STD-202, METHOD 213, COND. A
- VIBRATION: MIL-STD-202, METHOD 204, COND. B
- MOISTURE RESISTANCE: MIL-STD-202, METHOD 106 (OMIT 7a AND 7b)
- DURABILITY: 500 CYCLES MATING/UN-MATING

INSERT ARRANGEMENTS

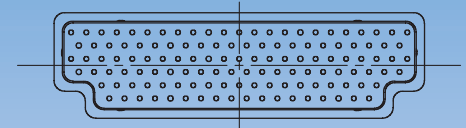

INSERT 127 - ALL SIZE 22

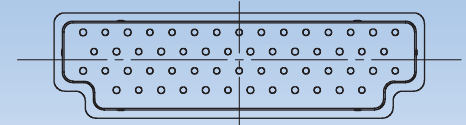

INSERT 56 - ALL SIZE 20

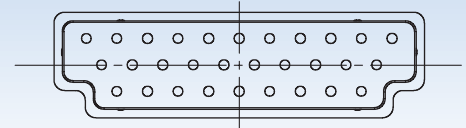

INSERT 31 - ALL SIZE 16

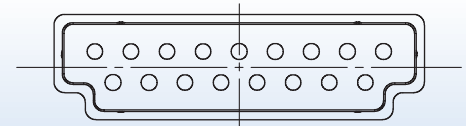

INSERT 17 - ALL SIZE 12

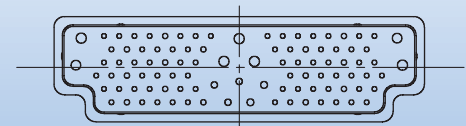

INSERT 98 - 86 SIZE 22
5 SIZE 20, 7 SIZE 16

R39 P 098 P T A 1 000

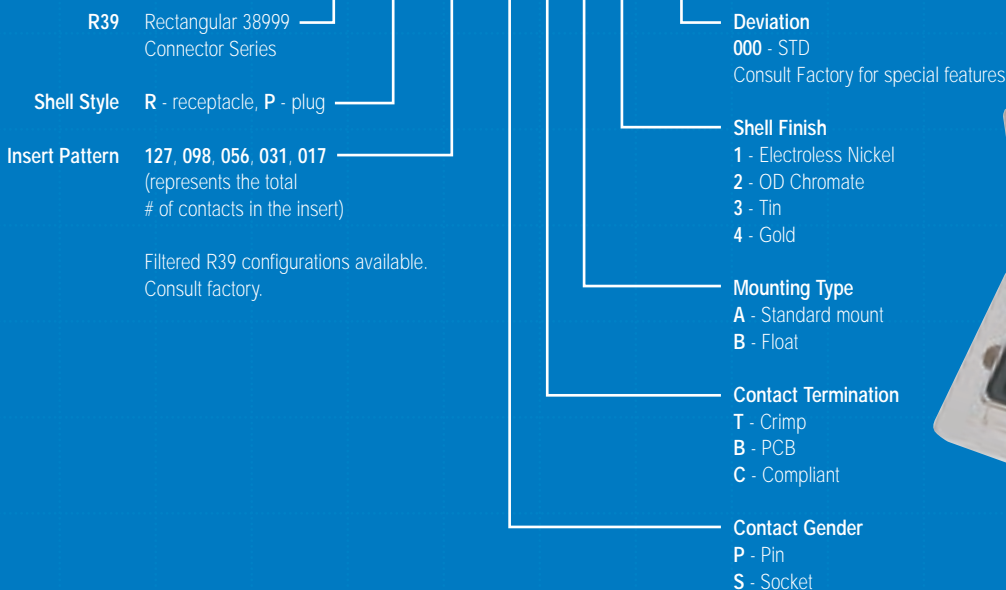

R39

Same outstanding quality and endurance.
Increased flexibility and value.

The R39 provides high performance in the severe environment demands of military specifications. Its lower profile translates into a smaller space-saving footprint and the new rectangular orientation provides additional installation options. It is also available in a high density, 127 pin contact version providing a wider range of engineering applications. It delivers the same reliable, familiar benefits found in our 38999 connector: effortless installation; blind push pull mating; extreme durability; quick mate and; "scoop-proof" recessed pin design. Using the same wide range of contacts, and the crimp and insert /removal tooling as 38999, it delivers just a little more.



- Rectangular 38999
- Rugged
- Blind Mate
- Available with EMI filtering

A m p h e n o l C u s t o m P r o d u c t s



**Amphenol custom products.
Helping to make design
dreams reality.**

Amphenol
Aerospace Products

C o n n e c t i n g S o l u t i o n s

Amphenol
Aerospace Products

Amphenol Canada Corp.
5950 14th Avenue
Markham, Ontario,
Canada L3S 4M4

Telephone: (416) 291-4401
Facsimile: (416) 292-0647
Email: sales@amphenolcanada.com
Website: www.amphenolcanada.com